

A

A

Diritti riservati All rights reserved

B

B

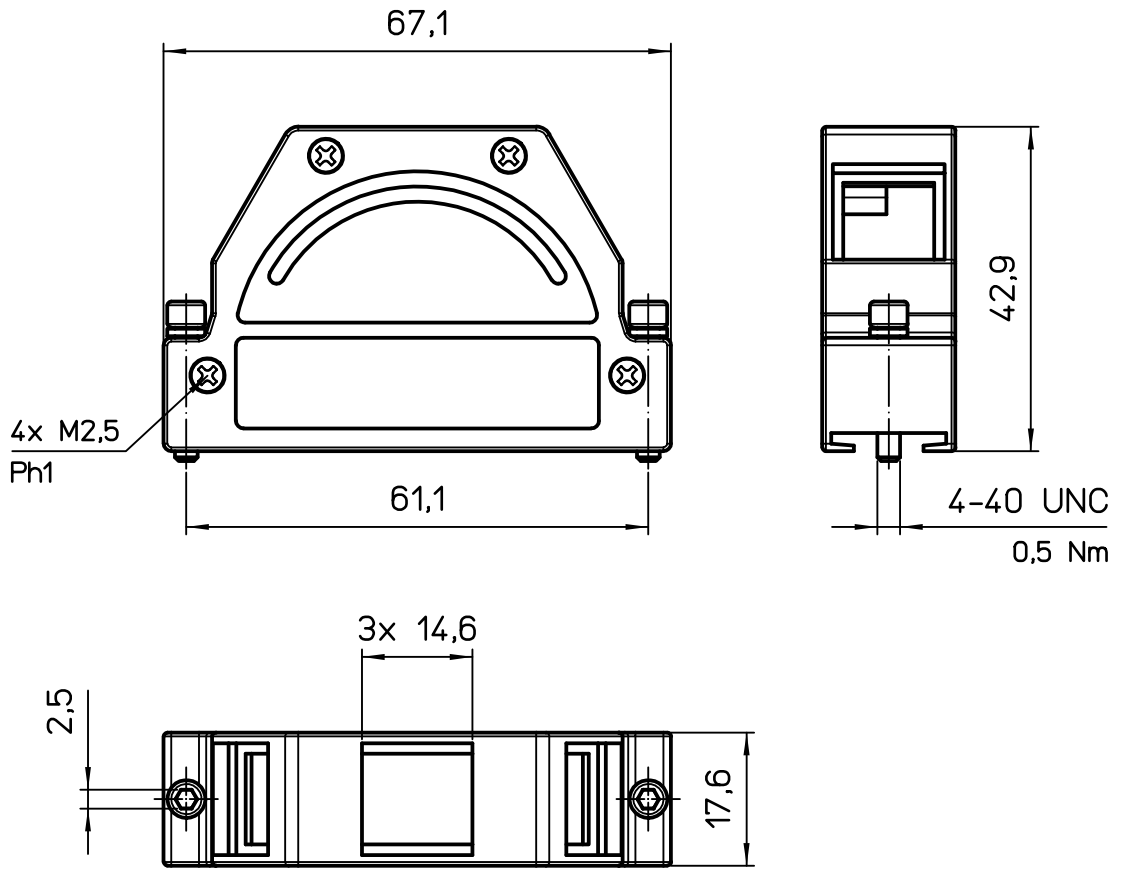

C

C

REV.	DATE	SIGNATURE		
Dimensions in mm		Simplified representation with dimensions without tolerance		
Original Size A4		CPTAV 50		Scale
Date 01/03/22		D-Sub metal housing, 50P, top/side entry, with 4-40 UNC fixing screws		1:1
Sign. S. Diasparra				